

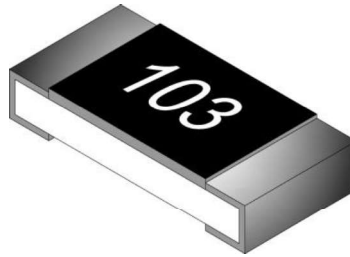

QUH Series Automotive Ultra High Power Chip Resistor Product Specifications

Document No.	S-10-12-43-07
Released Date	2021/03/02
Page No.	1/11

■ Automotive Ultra High Power Chip Resistor — QUH Series



■ Application

- Automotive electronics
- Navigation equipment, TPMS
- Heating, Ventilating and Air conditioning
- Indoor lighting, Central door locking, Wiper module

■ Features

- Small size and light weight
- Reliability, high quality
- CCD visual quality inspection
- AEC-Q200 Compliance

■ Parts Number Explanation

■ Example:

QUH	0603	F	10R0	P	05	Z
Product Type	Size (Inch)	Resistor Tolerance	Resistor Value	Package	Quantity	Optional
QUH	0402 0603 0805 1206 1210 2010 2512	D : ±0.5% F : ±1% G : ±2% J : ±5%	1R=1R00 10R=10R0 100R=100R 1K=1K00 1M=1M00	P : Paper Taping (0603~1210) Q : Paper Taping (0402) E : Embossed Taping	04 : 4000PCS 05 : 5000PCS 20 : 20000PCS 40 : 40000PCS 50 : 50000PCS	Z : Ultra High Power 7 : TCR ±200ppm



QUH Series Automotive Ultra High Power Chip Resistor Product Specifications

Document No.	S-10-12-43-07
Released Date	2021/03/02
Page No.	2/11

■ Ultra High Power Rating Electrical Specifications

Item Type	Rated Power at 70°C	Max Working Voltage	Max Overload Voltage	T.C.R. (PPM/ °C)	Resistance Range			
					D(±0.5%)	F(±1%) G(±2%)	J(±5%)	
QUH0402	0.2W	50V	100V	±400	-	$1\Omega \leq R < 10\Omega$		
				±100	$10\Omega \leq R \leq 1M\Omega$	$10\Omega \leq R \leq 10M\Omega$		
QUH0603	0.33W	150V	200V	±400	-	$1\Omega \leq R < 10\Omega$		
				±100	$10\Omega \leq R \leq 1M\Omega$	$10\Omega \leq R \leq 10M\Omega$		
QUH0805	0.5W	200V	300V	±400	-	$1\Omega \leq R < 10\Omega$		
				±100	$10\Omega \leq R \leq 1M\Omega$	$10\Omega \leq R \leq 10M\Omega$		
QUH1206	0.75W	200V	400V	±400	-	$1\Omega \leq R < 10\Omega$		
				±100	$10\Omega \leq R \leq 1M\Omega$	$10\Omega \leq R \leq 10M\Omega$		
QUH1210	1 W			±400	-	$1\Omega \leq R < 10\Omega$		
				±100	$10\Omega \leq R \leq 1M\Omega$	$10\Omega \leq R \leq 10M\Omega$		
QUH2010	1.5 W			±400	-	$1\Omega \leq R < 10\Omega$		
				±150	$10\Omega \leq R \leq 1M\Omega$	$10\Omega \leq R \leq 10M\Omega$		
QUH2512	3W			250V	500V	±400	-	$1\Omega \leq R < 10\Omega$
						±150	$10\Omega \leq R \leq 1M\Omega$	$10\Omega \leq R \leq 10M\Omega$

- For non-standard parts, please contact our sales dept.
- Operating Temperature Range : -55°C ~ +155°C.
- Type QUH0402/0603/0805/1206/1210/2010/2512 $1\Omega \leq R < 10\Omega$ optional code 「7」 is TCR: ±200PPM



**QUH Series Automotive Ultra High Power
Chip Resistor Product Specifications**

Document No.	S-10-12-43-07
Released Date	2021/03/02
Page No.	3/11

■ Type Dimension

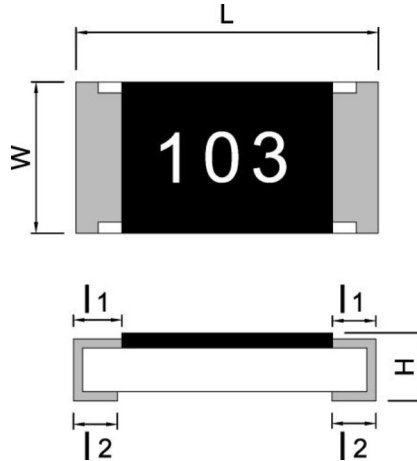

QUH0402 / QUH0603 / QUH0805 / QUH1206 / QUH1210 / QUH2010 / QUH2512

TYPE	L	W	H	l ₁	l ₂
QUH0402	1.00 ± 0.10	0.50 ± 0.05	0.30 ± 0.05	0.15 ± 0.10	0.20 ± 0.10
QUH0603	1.60 ± 0.20	0.80 ± 0.15	0.40 ± 0.10	0.30 ± 0.20	0.30 ± 0.10
QUH0805	2.00 ± 0.20	1.25 ± 0.15	0.50 ± 0.15	0.30 ± 0.15	0.40 ± 0.15
QUH1206	3.05 ± 0.10	1.60 ± 0.20	0.55 ± 0.15	0.40 ± 0.20	0.50 ± 0.20
QUH1210	3.05 ± 0.10	2.50 ± 0.20	0.55 ± 0.15	0.50 ± 0.20	0.50 ± 0.20
QUH2010	5.00 ± 0.20	2.50 ± 0.20	0.55 ± 0.10	0.60 ± 0.20	0.60 ± 0.20
QUH2512	6.30 ± 0.20	3.20 ± 0.20	0.68 ± 0.15	0.60 ± 0.20	0.60 ± 0.20



QUH Series Automotive Ultra High Power Chip Resistor Product Specifications

Document No.	S-10-12-43-07
Released Date	2021/03/02
Page No.	4/11

● General Information

■ Recommend Land Pattern Design

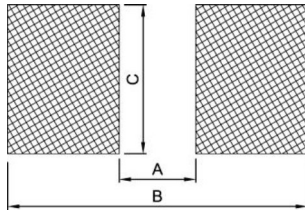

■ Dimension

Unit:mm

Item \ Type	0402	0603	0805	1206	1210	2010	2512
A	0.60	0.80	1.30	2.20	2.00	3.80	4.90
B	1.60	2.40	2.90	4.20	4.40	6.60	8.10
C	0.70	1.00	1.40	1.70	2.70	2.70	3.40

■ Performance Characteristics

■ Power Derating Curve

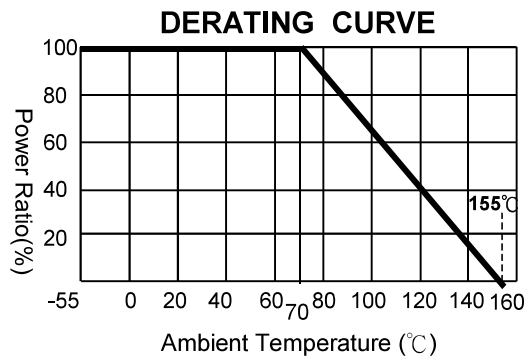

Power rating or current rating is in the case based on continuous full-load at ambient temperature of 70°C.

For operation at ambient temperature in excess of 70°C, the load should be derated in accordance with figure of derating Curve.

■ Voltage Rating or Current Rating

Resistance Range: $\geq 1\Omega$

Rated Voltage: The resistor shall have a DC continuous working voltage or a RMS AC continuous working voltage at commercial-line frequency and wave form corresponding to the power rating, as determined formula as following:

$$E(RCWV) = \sqrt{P \times R}$$

E=Rated voltage(V)

P=Power rating(W)

R=Nominal resistance(Ω)



QUH Series Automotive Ultra High Power Chip Resistor Product Specifications

Document No.	S-10-12-43-07
Released Date	2021/03/02
Page No.	5/11

● Reliability Test and Requirement

Test Item	Test Method	Procedure	Requirements
Temperature Coefficient of Resistance (T.C.R)	JIS-C-5201-1 4.8 IEC-60115-1 4.8	At 25 / -55°C and 25°C / +155°C, 25°C is the reference temperature	As Spec
Short Time Overload	JIS-C-5201-1 4.13 IEC-60115-1 4.13	Ultra Power : 5 × Rated power or Max Overload Voltage whichever is less for 5 seconds	±1 : ±(1.0%+0.05Ω) ±5 : ±(2.0%+0.1Ω) Value <1Ω : ±(2.0%+0.1Ω)
Leaching	JIS-C-5201-1 4.18 IEC-60068-2-58 8.2.1	260±5°C for 30 seconds.	Individual leaching area ≤5% Total leaching area ≤ 10%
Resistance to Soldering Heat	JIS-C-5201-1 4.18 IEC-60115-1 4.18	260±5°C for 10 seconds.	±1 : ±(0.5%+0.05Ω) ±5 : ±(1.0%+0.05Ω) Value <1Ω : ±(1.0%+0.05Ω)
Insulation Resistance	JIS-C-5201-1 4.6 IEC-60115-1 4.6	Apply 100VDC for 1 minute.	≥ 10GΩ
Temperature Cycling	JESD22 Method JA-104	1000 Cycles (-55°C to +125°C) Measurement at 24±4 hours after test conclusion. 30min maximum dwell time at each temperature extreme.	1% : ±(0.5%+0.05Ω) 5% : ±(1.0%+0.10Ω)
Resistance to Solvent	MIL-STD-202 Method 215	Add Aqueous wash chemical - OKEM Clean or equivalent.	1% : ±(0.5%+0.05Ω) 5% : ±(0.5%+0.05Ω)
Biased Humidity	MIL-STD-202 Method 103	1,000 hours; 85°C / 85% RH, 10% of operating power. Measurement at 24±4 hours after test conclusion.	1% : ±(1.0%+0.05Ω) 5% : ±(3.0%+0.05Ω)
High Temperature Exposure (Storage)	MIL-STD-202 Method 108	1000 hrs. @ T=125°C. Unpowered. Measurement at 24±4 hours after test conclusion.	1% : ±(0.5%+0.05Ω) 5% : ±(2.0%+0.05Ω)
Operational Life	MIL-STD-202 Method 108	Condition D Steady State TA=125°C at derated power. Measurement at 24±4 hours after test conclusion.	1% : ±(1.0%+0.05Ω) 5% : ±(3.0%+0.10Ω)
External Visual	MIL-STD-883 Method 2009	Electrical test not required. Inspect device construction, marking and workmanship.	—
Mechanical Shock	MIL-STD-202 Method 213)Test ½ Sine Pulse, Peak value: 100g, normal duration: 6ms, Velocity change: 12.3ft/sec. 6 shocks in each direction, total 18 shocks.	±1 : ±(1.0%+0.05Ω) ±5 : ±(2.0%+0.1Ω)
Vibration	MIL-STD-202 Method 204	5 g's for 20 min., 12 cycles each of 3 orientations. Note: Test from 10-2000 Hz	±1 : ±(1.0%+0.05Ω) ±5 : ±(2.0%+0.1Ω)
ESD	AEC-Q200- 002 or ISO/DIS 10605	Human body model 0402 / 0603 : 1KV 0805 and above : 2KV	±(3%+0.05Ω)
Solderability	J-STD-002	(1) 4 hrs 155°C dry heat (2) 245±5°C 3 sec.	±1 : ±(0.5%+0.05Ω) ±5 : ±(1.0%+0.05Ω)
Terminal Strength (SMD)	AEC Q200-006	Pressurizing force for 60 seconds 0402 / 0603 : 8N ; 0805 and above : 17.7N	No broken
Board Flex	AEC Q200-005	Bending once for 60 seconds 2010, 2512 sizes: 2mm Other sizes: 3mm	±1 : ±(1.0%+0.05Ω) ±5 : ±(1.0%+0.05Ω)



QUH Series Automotive Ultra High Power Chip Resistor Product Specifications

Document No.	S-10-12-43-07
Released Date	2021/03/02
Page No.	6/11

Recommended Customer Soldering Parameters

Wave solder Temperature condition

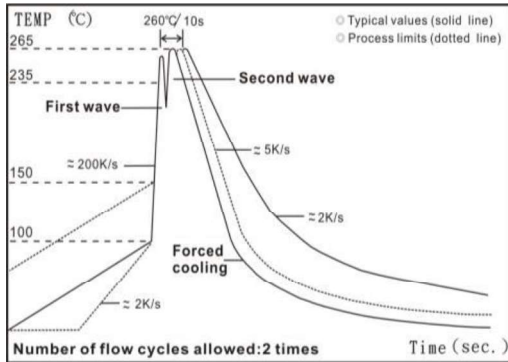

Solder reflow Temperature condition

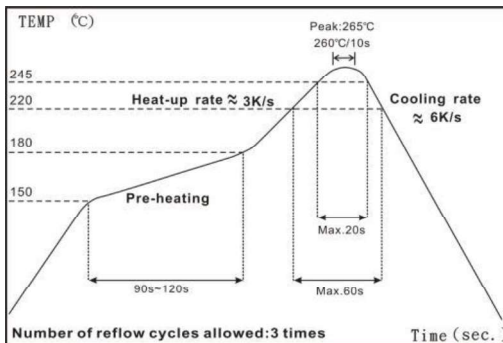

■ Rework temperature (hot air equipment) : 350°C, 3~5seconds

Recommended reflow methods

IR, vapor phase oven, hot air oven

If reflow temperatures exceed the recommended profile, devices may not meet the performance requirements



**QUH Series Automotive Ultra High Power
Chip Resistor Product Specifications**

Document No.	S-10-12-43-07
Released Date	2021/03/02
Page No.	7/11

■ **Appendix For SMD Chip Resistor**

● **Packaging Information**

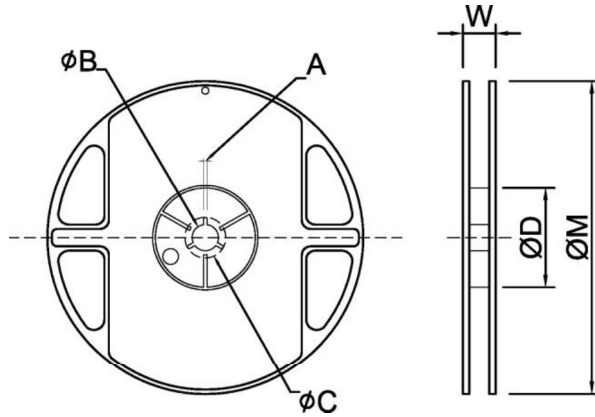

■ **Dimension**

Unit:mm

TYPE	SIZE	A	φB	φC	φD	W	φM	
0402	7"	10K/Reel	2.0±0.5	13.5±1.0	21±1.0	60±1.0	11.5±2.0	178±2.0
	13"	40K/50K Reel	2.0±0.5	13.5±1.0	21±1.0	100±1.0	11.5±2.0	330±2.0
0603/0805/1206/1210	7"	5K/Reel	2.0±0.5	13.5±1.0	21±1.0	60±1.0	11.5±2.0	178±2.0
0603/0805 /1206	10"	10K/Reel	2.0±0.5	13.5±1.0	21±1.0	100±1.0	11.5±2.0	254±2.0
	13"	20K/Reel	2.0±0.5	13.5±1.0	21±1.0	100±1.0	11.5±2.0	330±2.0
2010/2512	7"	4K/Reel	2.0±0.5	13.5±1.0	21±1.0	60±1.0	16.0±2.0	178±2.0



QUH Series Automotive Ultra High Power Chip Resistor Product Specifications

Document No.	S-10-12-43-07
Released Date	2021/03/02
Page No.	8/11

■ Tapping Specification

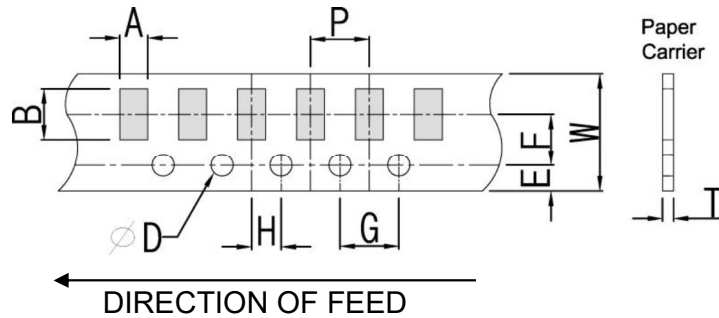

■ Dimension

Unit:mm

Packaging	Type	A	B	W	E	F	G	H	T	ϕD	P
Paper Type	0402	0.70±0.1	1.20±0.1	8.0±0.2	1.75±0.1	3.5±0.05	4.0±0.1	2.0±0.05	0.45±0.1	1.50 ^{+0.10} ₋₀	2.0±0.1
	0603	1.05±0.2	1.80±0.2	8.0±0.2	1.75±0.1	3.5±0.05	4.0±0.1	2.0±0.05	0.60±0.1		4.0±0.1
	0805	1.55±0.2	2.30±0.2	8.0±0.2	1.75±0.1	3.5±0.05	4.0±0.1	2.0±0.05	0.75±0.1		
	1206	1.90±0.2	3.50±0.2	8.0±0.2	1.75±0.1	3.5±0.05	4.0±0.1	2.0±0.05	0.75±0.1		
	1210	2.85±0.2	3.50±0.2	8.0±0.2	1.75±0.1	3.5±0.05	4.0±0.1	2.0±0.05	0.75±0.1		

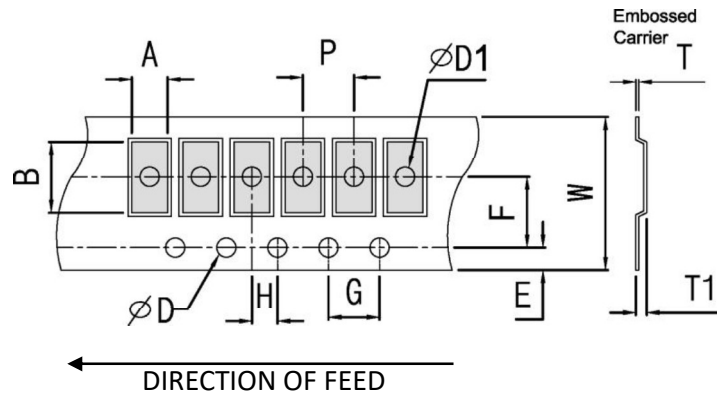

■ Dimension

Unit:mm

Packaging	Type	A	B	W	E	F	G	H	T	ϕD	$\phi D1$	T1	P
Embossed Type	2010	2.80±0.2	5.60±0.2	12±0.1	1.75±0.1	5.5±0.05	4.0±0.1	2.0±0.05	0.23±0.1	1.50 ^{+0.10} ₋₀	1.50±0.1	0.85±0.15	4.0±0.1
	2512	3.40±0.2	6.70±0.2	12±0.1	1.75±0.1	5.5±0.05	4.0±0.1	2.0±0.05	0.23±0.1		1.50±0.1	0.95±0.15	



QUH Series Automotive Ultra High Power Chip Resistor Product Specifications

Document No.	S-10-12-43-07
Released Date	2021/03/02
Page No.	9/11

■ Packing Material Data/Storage Data

■ Front & Back Lead Dimension

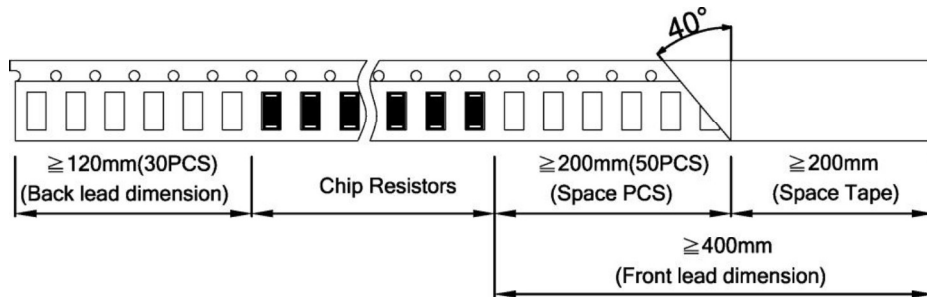

■ Top Adhesive Peel Off Strength : 10~70g

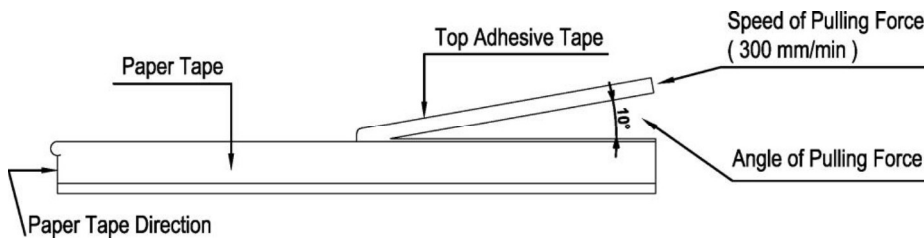

■ Package

Inner Box Size	
Reel	Size H(mm)
1	13
2	24
3	36
5	60
10	113

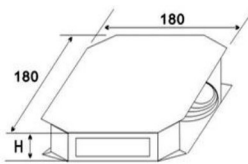

External Box Size			
Contain (Kpcs)	Length (mm)	Width (mm)	Height (mm)
25K	180	180	60
50K	180	180	110
150K	430	200	200
300K	400	400	200

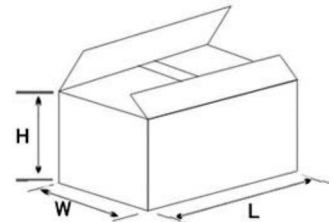

■ Storage Data :

Storage time at the environment temp: $25\pm 5^\circ\text{C}$ & humidity: $60\pm 20\%$ is valid for one year from the date of delivery.



QUH Series Automotive Ultra High Power Chip Resistor Product Specifications

Document No.	S-10-12-43-07
Released Date	2021/03/02
Page No.	10/11

■ Product Testing Method:

Our products are tested with our company's tapping & testing equipments by using four-foot probe to touch at the back of both electrodes. Supposed different testing points or methods are requested, please advise beforehand and customized-made production is available.

■ 0603 E-96 Multiplier Code

Code	A	B	C	D	E	F	G	H	X	Y	Z
Multiplier	10 ⁰	10 ¹	10 ²	10 ³	10 ⁴	10 ⁵	10 ⁶	10 ⁷	10 ⁻¹	10 ⁻²	10 ⁻³

CODING FORMULA

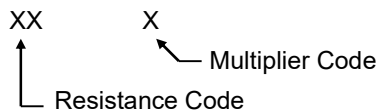

Example: 10.2KΩ = 102 x 10²Ω =02C

02 C

33.2Ω = 332 x 10⁻¹Ω =51X

51 X

■ 0603 Standard E-96 Values and 0603 Resistance Codes

R-Value	100	102	105	107	110	113	115	118	121	124	127	130	133	137	140	143	147	150	154	158	162	165	169	174
Code	01	02	03	04	05	06	07	08	09	10	11	12	13	14	15	16	17	18	19	20	21	22	23	24
R-Value	178	182	187	191	196	200	205	210	215	221	226	232	237	243	249	255	261	267	274	280	287	294	301	309
Code	25	26	27	28	29	30	31	32	33	34	35	36	37	38	39	40	41	42	43	44	45	46	47	48
R-Value	316	324	332	340	348	357	365	374	383	392	402	412	422	432	442	453	464	475	487	499	511	523	536	549
Code	49	50	51	52	53	54	55	56	57	58	59	60	61	62	63	64	65	66	67	68	69	70	71	72
R-Value	562	576	590	604	619	634	649	665	681	698	715	732	750	768	787	806	825	845	866	887	909	931	953	976
Code	73	74	75	76	77	78	79	80	81	82	83	84	85	86	87	88	89	90	91	92	93	94	95	96



QUH Series Automotive Ultra High Power Chip Resistor Product Specifications

Document No.	S-10-12-43-07
Released Date	2021/03/02
Page No.	11/11

■ Standard Resistance Values in a Decade

Marking code:

- 1%: marking code, please refer to E96 and E24 data form as below
 Ex: 120K, The marking code is 1203 in E24
 121K, The marking code is 1213 in E96
- 5%: marking code, please refer to E24 data form as below
 Ex: 120K, The marking code is 124 in E24
- Note: 0402 series resistor has no marking code.
- Type: 0603 1% marking code, please refer to E-96 multiplier code.
- **Note: jumper zero ohm resistor marking code is one 「0」 (except type below 0402).**

E96	E48	E96	E48	E96	E48	E96	E48	E96	E48						
100	100	169	169	287	287	487	487	825	825						
102		174		294		499		845							
105	105	178	178	301	301	511	511	866	866						
107		182		309		523		887							
110	110	187	187	316	316	536	536	909	909						
113		191		324		549		931							
115	115	196	196	332	332	562	562	953	953						
118		200		340		576		976							
121	121	205	205	348	348	590	590								
124		210		357		604						E24	E12	E6	E3
127	127	215	215	365	365	619	619	10	10	10	10				
130		221		374		634		11							
133	133	226	226	383	383	649	649	12	12						
137		232		392		665		13							
140	140	237	237	402	402	681	681	15	15	15					
143		243		412		698		16							
147	147	249	249	422	422	715	715	18	18						
150		255		432		732		20							
154	154	261	261	442	442	750	750	22	22	22	22				
158		267		453		768		24							
162	162	274	274	464	464	787	787	27	27						
165		280		475		806		30							
								33	33	33					
								36							
								39	39						
								43							
								47	47	47	47				
								51							
								56	56						
								62							
								68	68	68					
								75							
								82	82						
								91							

According to IEC publication 63