

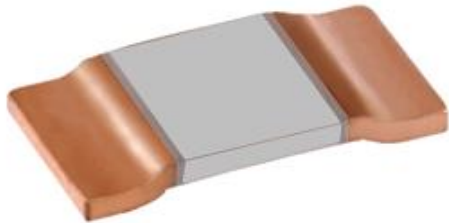

**SR Series Metal Alloy Shunt Two Terminal Low-Resistance Resistor  
Product Specifications**

<b>Document No.</b>	S-10-12-04-06
<b>Released Date</b>	2020/02/10
<b>Page No.</b>	1/8

**■ Metal Alloy Shunt Two Terminal Low-Resistance Chip Resistor— SR Series**



**■ Application**

- Power modules
- High current Power Supply
- Motor Driver
- Industrial
- Battery management system
- Automotive

**■ Features**

- Low Resistance / TCR
- Excellent long-term stability
- RoHs compliant and halogen free.
- Lead free.
- High precision current sensing and voltage division.
- Excellent Anti-Surge ability .
- AEC-Q200 compliant

**■ Parts Number Explanation**

**■ Example:**

<b>SR</b>	<b>2512</b>	<b>20</b>	<b>F</b>	<b>R004</b>	<b>M</b>	<b>Z</b>
<b>Product Type</b>	<b>Size (Inch)</b>	<b>Rated Power</b>	<b>Tolerance</b>	<b>Resistance</b>	<b>Material</b>	<b>Optional</b>
	1206 2512 3920 5930	20=2.00W 25=2.50W 30=3.00W 50=5.00W .. .. .. T0=10.0W T2=12.0W	F : ±1% G : ±2% J : ±5%	0m50=0.5mR R001=1.0mR R005=5mR	S : MnCuSn M : MnCu F : FeCrAl	



**SR Series Metal Alloy Shunt Two  
Terminal Low-Resistance Resistor  
Product Specifications**

<b>Document No.</b>	S-10-12-04-06
<b>Released Date</b>	2020/02/10
<b>Page No.</b>	2/8

■ **Standard Electrical Specifications**

Type	Power Rating at 70°C	T.C.R. (ppm/°C)	Max. Rating Current(A)	Max. Overload Current(A)	Resistance Range (mΩ)	Material	Operating Temperature Range (°C)
					1.0% (F) 2.0% (G) 5.0% (J)		
SR1206	2W	≤ ±300	81.6	182.57	0.3	MnCuSn	- 65 ~ + 170
	2W	≤ ±200	63.24	141.42	0.5	MnCuSn	
	2W	≤ ±150	44.72	100	1	MnCu	
SR2512	6W	≤ ±200	154.92	346.41	0.25	MnCuSn	
	6W	≤ ±150	141.42	316.22	0.3	MnCuSn	
	6W	≤ ±115	109.54	244.94	0.5	MnCu	
	5W	≤ ±115	81.65	182.57	0.75	MnCu	
	5W	≤ ±100	70.71	158.11	1	MnCu	
	5W	≤ ±50	50	111.80	2	FeCrAl	
	4W	≤ ±50	36.51	81.65	3	FeCrAl	
	3W	≤ ±50	27.38	61.23	4	FeCrAl	
	2.5W	≤ ±50	22.36	50	5	FeCrAl	
SR3920	12W	≤ ±200	244.94	547.72	0.2	MnCuSn	
	10W	≤ ±150	182.57	408.24	0.3	MnCu	
	9W	≤ ±75	134.16	300	0.5	MnCu	
	8W	≤ ±50	89.44	200	1	FeCrAl	
	7W	≤ ±50	83.66	187.08	1	MnCu	
	7W	≤ ±50	68.31	152.75	1.5	FeCrAl	
	6W	≤ ±50	54.77	122.47	2	FeCrAl	
	5W	≤ ±50	40.82	91.28	3	FeCrAl	
	4W	≤ ±50	31.62	70.71	4	FeCrAl	
	3W	≤ ±50	24.49	54.77	5	FeCrAl	
SR5930	15W	≤ ±100	273.86	612.37	0.2	MnCu	
	10W	≤ ±100	182.57	408.24	0.3	MnCu	
	8W	≤ ±75	126.49	282.84	0.5	MnCu	
	8W	≤ ±50	89.44	200	1	FeCrAl	
	7W	≤ ±50	59.16	132.28	2	FeCrAl	
	5W	≤ ±50	40.82	91.28	3	FeCrAl	

- For non-standard parts, please contact our sales dept.
- Power rating is guaranteed when terminal temperature of resistor is below 70°C



**SR Series Metal Alloy Shunt Two  
Terminal Low-Resistance Resistor  
Product Specifications**

<b>Document No.</b>	S-10-12-04-06
<b>Released Date</b>	2020/02/10
<b>Page No.</b>	3/8

**■ Type Dimension**

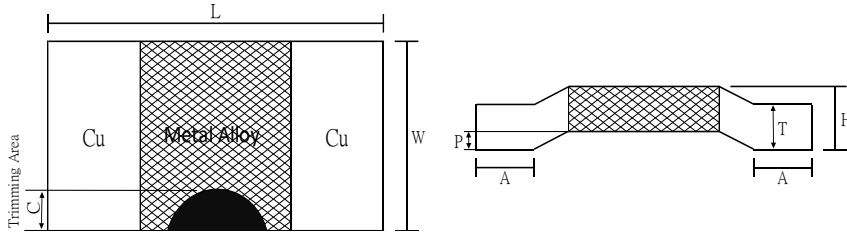

**■ Dimension**

**Unit : mm**

TYPE	Resistance	L	W	H	T	A	C (Max.)	p	Material
SR1206	0.3mR	3.2±0.3	1.65±0.3	1.20±0.15	-	0.80±0.2	-	-	MnCuSn
	0.5mR 1mR	3.2±0.3	1.65±0.3	0.90±0.15	-	0.80±0.2	-	-	MnCuSn MnCu
SR2512	0.25mR	6.5±0.3	3.25±0.3	1.35±0.15	1.00±0.15	0.90±0.2	0.4	0.35±0.1	MnCuSn
	0.3mR			1.17±0.15	0.82±0.15				MnCuSn
	0.5mR			1.07±0.15	0.72±0.15				MnCu
	0.75mR			0.95±0.15	0.6±0.15				MnCu
	1mR			0.73±0.15	0.38±0.15				MnCu
	2mR			0.96±0.15	0.61±0.15				FeCrAl
	3mR			0.76±0.15	0.41±0.15				FeCrAl
	4mR			0.66±0.15	0.31±0.15				FeCrAl
5mR	0.66±0.15	0.31±0.15	FeCrAl						
SR3920	0.2mR	10.2±0.30	5.20±0.3	1.98±0.15	1.48±0.15	1.8±0.3	0.6	0.50±0.1	MnCuSn
	0.3mR			1.92±0.15	1.42±0.15				MnCu
	0.5mR			1.36±0.15	0.86±0.15				MnCu
	1mR			0.92±0.15	0.42±0.15				MnCu
	1mR			1.87±0.15	1.37±0.15				FeCrAl
	1.5mR			1.46±0.15	0.96±0.15				FeCrAl
	2mR			1.19±0.15	0.69±0.15				FeCrAl
	3mR			0.94±0.15	0.44±0.15				FeCrAl
	4mR			0.85±0.15	0.35±0.15				FeCrAl
	5mR			0.85±0.15	0.35±0.15				FeCrAl
SR5930	0.2mR	15±0.3	7.75±0.3	1.92±0.15	1.42±0.15	4.2±0.2	1.0	0.50±0.1	MnCu
	0.3mR			1.44±0.15	0.94±0.15				MnCu
	0.5mR			1.08±0.15	0.58±0.15				MnCu
	1mR			1.37±0.15	0.87±0.15				FeCrAl
	2mR			0.95±0.15	0.46±0.15				FeCrAl
	3mR			0.90±0.15	0.40±0.15				FeCrAl



# SR Series Metal Alloy Shunt Two Terminal Low-Resistance Resistor Product Specifications

Document No.	S-10-12-04-06
Released Date	2020/02/10
Page No.	4/8

## ■ Performance Characteristics

### Power Derating Curve

The Operating Temperature Range: -65°C ~+170°C.

Terminal temperatures above 70°C, power rating must be derated in accordance with the curve as below :

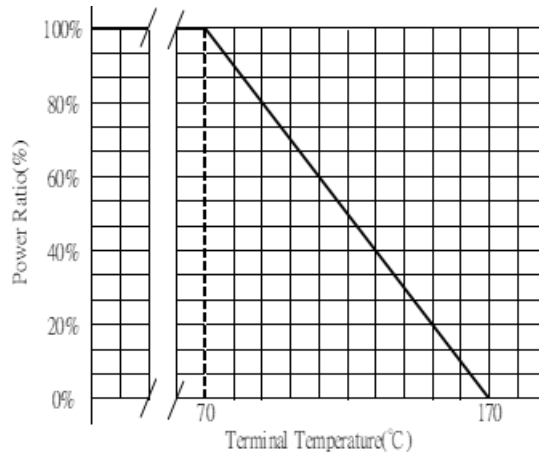

### ■ Rating Current

The following equation may be used to determine the DC (Direct Current) or AC (Alternating Current) (RMS, root mean square value) of normal rated power. However, if the result value exceeds the highest current of regulated standards, the highest normal rated power is to be used

$$I = \sqrt{P/R}$$

I = Rating current (A)  
P= Rating Power (W)  
R= Resistance(Ω)

### ■ Marking Format:

- 1206 no marking.
- 2512/3920/5930 marking are 3 digits.
- “L” designates the decimal location in milliohm  
e.g. 3mΩ the product marking is 3L0.  
0.3mΩ the product marking is L30.
- The criteria to distinguishing the mark on the surface of products are that characters can be identified.



# SR Series Metal Alloy Shunt Two Terminal Low-Resistance Resistor Product Specifications

Document No.	S-10-12-04-06
Released Date	2020/02/10
Page No.	5/8

## ■ Reliability Test and Requirement

Test Item	Test Method	Procedure	Requirements
Temperature Coefficient of Resistance (T.C.R)	JIS-C-5201-1 4.8 IEC-60115-1 4.8	At 25°C /+125°C, 25°C is the reference temperature	As Spec
Short Time Overload	JIS-C-5201-1 4.13 IEC-60115-1 4.13	The number of rated power are as follows: <ul style="list-style-type: none"> <li>● SR1206: 5 times of rated power</li> <li>● SR2512: 5 times of rated power</li> <li>● SR3920: 5 times of rated power</li> <li>● SR5930: 5 times of rated power</li> </ul> for 5 seconds.	$\Delta R/R1 \leq \pm(1.0\%+0.0005\Omega)$
High Temperature Exposure (Storage)	MIL-STD-202 Method 108	1000 hrs. @ T=170°C. Unpowered. Measurement at 24±4 hours after test conclusion.	$\Delta R/R1 \leq \pm(1.0\%+0.0005\Omega)$
Temperature Cycling	JESD22 Method JA-104	1000 Cycles (-55°C to +155°C) Measurement at 24±4 hours after test conclusion. 30min maximum dwell time at each temperature extreme.	$\Delta R/R1 \leq \pm(1.0\%+0.0005\Omega)$
Biased Humidity	MIL-STD-202 Method 103	1,000 hours; 85°C / 85% RH, 10% of operating power. Measurement at 24±4 hours after test conclusion.	$\Delta R/R1 \leq \pm(1.0\%+0.0005\Omega)$
Operation Life	MIL-STD-202 Method 108	Condition D Steady State TA=125°C at derated power. Measurement at 24±4 hours after test conclusion.	$\Delta R/R1 \leq \pm(1.0\%+0.0005\Omega)$
Moisture Resistance	MIL-STD-202, Method 106	Humidity of 90~98% and a temperature of 25°C / 65°C ,10 cycles	$\Delta R/R1 \leq \pm(1.0\%+0.0005\Omega)$
Mechanical Shock	MIL-STD-202 Method 213	)Test ½ Sine Pulse, Peak value: 100g, normal duration: 6ms, Velocity change:12.3ft/sec.	$\Delta R/R1 \leq \pm(0.5\%+0.0005\Omega)$
Vibration	MIL-STD-202 Method 204	5 g's for 20 min., 12 cycles each of 3 orientations. Note: Test from 10-2000Hz	$\Delta R/R1 \leq \pm(0.5\%+0.0005\Omega)$
Board Flex	AEC Q200-005	Beading once for 60 seconds ,2mm	$\Delta R/R1 \leq \pm(1.0\%+0.0005\Omega)$
Solderability	J-STD-002	(1) 4 hrs 155°C dry heat (2) 245±5°C 3 sec.	>95% coverage(electrode area)

● Note : All Reliability test should follow De-rating curve , terminal temperature of component should be below 70°C .

● Note : Footprint size, solder insufficient, excessive solder, solder void and component shifted will affect the resistance accuracy after IR reflow. Circuit calibration is a must to be done by functional test.



# SR Series Metal Alloy Shunt Two Terminal Low-Resistance Resistor Product Specifications

Document No.	S-10-12-04-06
Released Date	2020/02/10
Page No.	6/8

## ■ Anti-Surge Ability:

Pulse Power Characteristics – SR1206 0.5mR

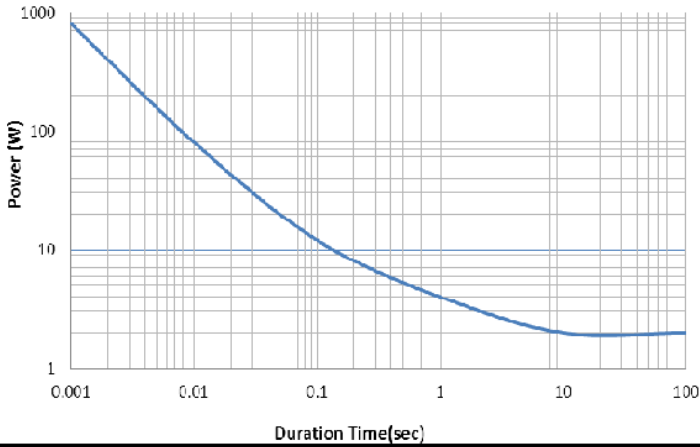

SR2512 Series Pulsed Power Characteristics

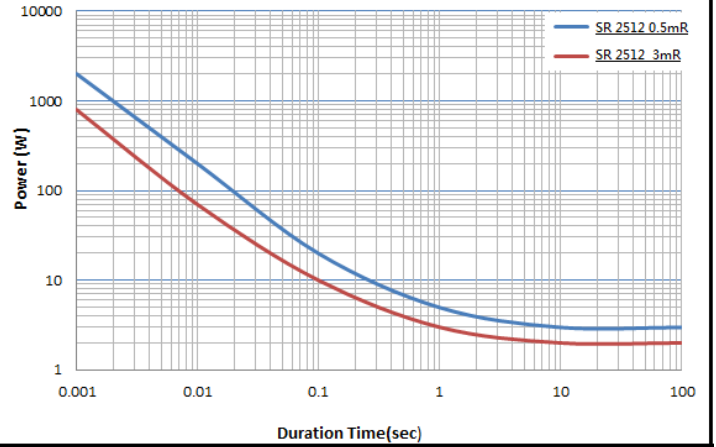

SR 3920 Series Pulsed Power Characteristics

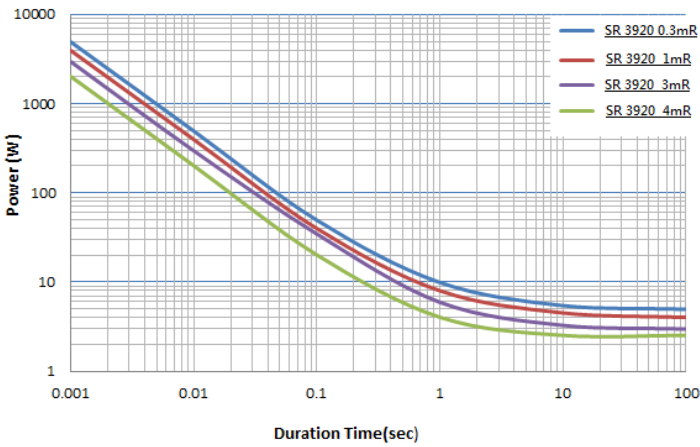

SR 5930 Series Pulsed Power Characteristics

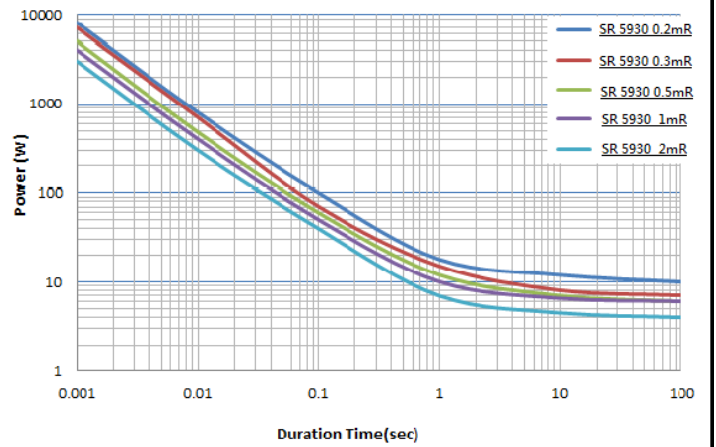

## ■ Recommended Customer Soldering Parameters:

### ■ Solder reflow Temperature condition

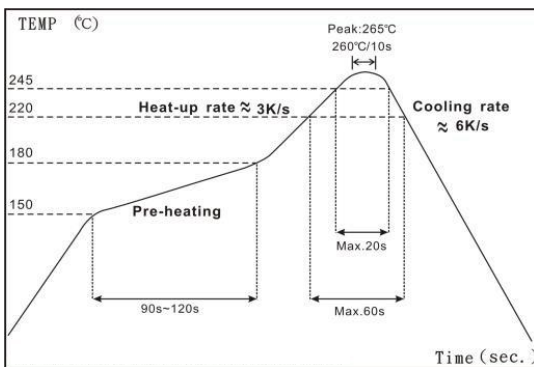



**SR Series Metal Alloy Shunt Two Terminal Low-Resistance Resistor Product Specifications**

Document No.	S-10-12-04-06
Released Date	2020/02/10
Page No.	7/8

■ Recommend Land Pattern Design

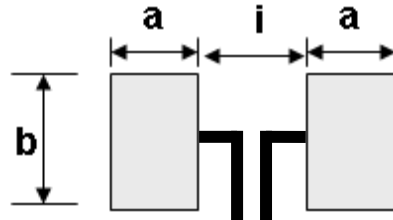

■ Dimension

Unit: mm

TYPE	Resistance Range	a	b	i
SR1206	0.3mΩ~1mΩ	2.10	1.80	1.40
SR2512	0.25mΩ~5mΩ	1.80	3.40	3.80
SR3920	0.2mΩ~5mΩ	2.70	6.20	5.60
SR5930	0.2mΩ~3mΩ	5.20	8.75	5.60

■ Packing Quantity

TYPE	PCS /Reel
SR1206	2,000
SR2512	4,000
SR3920	3,000
SR5930	2,000

■ Storage Temperature

Temperature : 25±5°C, Humidity : 60±20%

■ Appendix For SMD Chip Resistor

● Packaging Information

■ Reel Dimensions

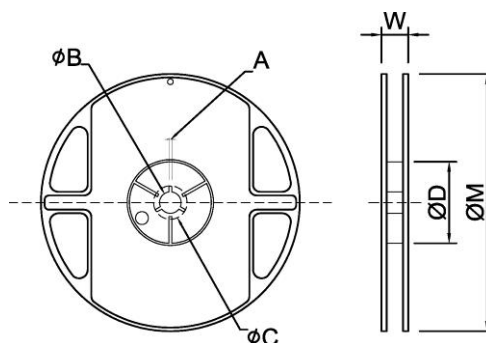



# SR Series Metal Alloy Shunt Two Terminal Low-Resistance Resistor Product Specifications

Document No.	S-10-12-04-06
Released Date	2020/02/10
Page No.	8/8

### Dimension

Unit: mm

Reel Type / Tape	A	$\phi B$	$\phi C$	$\phi D$	W	$\phi M$
7" reel for 8 mm embossed	2±0.5	13.0±0.5	17.7±0.5	60.0±0.5	12.0±0.5	178±1.0
10" reel for 12 mm embossed	2±0.5	13.0±0.5	17.7±0.5	62.0±0.5	16.5±0.5	250±1.0
13" reel for 16 mm embossed	2.5±0.5	13.5±0.5	17.7±0.5	99.0±0.5	20.7±0.5	330±1.0
13" reel for 24 mm embossed	2.5±0.5	13.5±0.5	17.7±0.5	99.0±0.5	29.4±0.5	330±1.0

### Embossed Dimensions

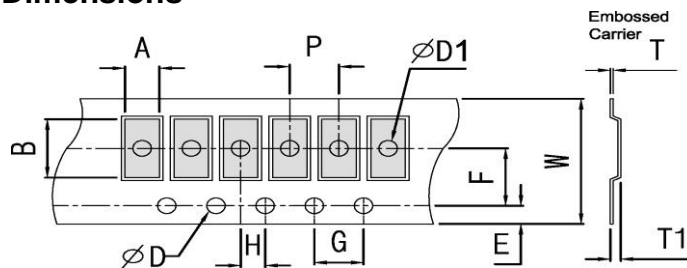

### Dimension

Unit: mm

Item	Resistance ( $\Omega$ )	W	P	E	F	$\phi D$	G	H	A	B	T1
SR1206	0.3m, 0.5m, 1m	8.0±0.30	4.0±0.10	1.75±0.10	3.5±0.10	1.50 <sup>+0.1</sup> <sub>-0</sub>	4.0±0.10	2.0±0.10	1.88±0.10	3.56±0.10	1.40±0.10
SR2512	0.25m, 0.3m, 0.5m, 0.75m, 2m	12.0±0.30	4.0±0.10	1.75±0.10	5.5±0.10	1.50 <sup>+0.1</sup> <sub>-0</sub>	4.0±0.10	2.0±0.10	3.55±0.10	6.75±0.10	1.40±0.10
	1m, 3m	12.0±0.30	4.0±0.10	1.75±0.10	5.5±0.10	1.50 <sup>+0.1</sup> <sub>-0</sub>	4.0±0.10	2.0±0.10	3.55±0.10	6.75±0.10	1.10±0.10
	4m, 5m	12.0±0.30	4.0±0.10	1.75±0.10	5.5±0.10	1.50 <sup>+0.1</sup> <sub>-0</sub>	4.0±0.10	2.0±0.10	3.55±0.10	6.75±0.10	0.80±0.10
SR3920	0.2m, 0.3m, 0.5m, 2m, 1mR(8W), 1.5mR	16.0±0.30	8.0±0.10	1.75±0.10	7.5±0.10	1.50 <sup>+0.1</sup> <sub>-0</sub>	4.0±0.10	2.0±0.10	5.5±0.10	10.8±0.10	1.97±0.10
	1m(7W), 3m, 4m, 5m	16.0±0.30	8.0±0.10	1.75±0.10	7.5±0.10	1.50 <sup>+0.1</sup> <sub>-0</sub>	4.0±0.10	2.0±0.10	5.5±0.10	10.8±0.10	1.25±0.10
SR5930	0.2m, 0.3m, 1m	24.0±0.30	12.0±0.10	1.75±0.10	11.5±0.10	1.50 <sup>+0.1</sup> <sub>-0</sub>	4.0±0.10	2.0±0.10	8.3±0.10	15.4±0.10	2.30±0.10
	0.5m, 2m, 3m	24.0±0.30	12.0±0.10	1.75±0.10	11.5±0.10	1.50 <sup>+0.1</sup> <sub>-0</sub>	4.0±0.10	2.0±0.10	8.3±0.10	15.4±0.10	1.40±0.10